

MEDIMEX

ABOUT ACCESSORIES

ATLANTIC

SERIE



HORNACINA 33X33 CM

Cuadrada de 33x33cm
Profundidad 10cm.
Fabricada en acero inox. S.304
6 acabados de color

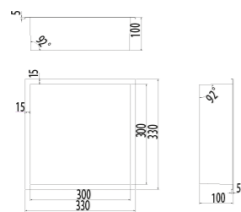
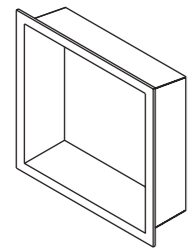

Ref: **HOR001/BL**
P.V.P: **80 €**
IVA NO INCLUIDO



Ref: **HOR001/NG**
P.V.P: **75 €**
IVA NO INCLUIDO



Ref: **HOR001/NQ**
P.V.P: **66 €**
IVA NO INCLUIDO



Ref: **HOR001/BGM**
P.V.P: **86 €**
IVA NO INCLUIDO



Ref: **HOR001/OC**
P.V.P: **83 €**
IVA NO INCLUIDO



Ref: **HOR001/ORC**
P.V.P: **86 €**
IVA NO INCLUIDO

PACIFIC

SERIE



HORNACINA 63X33 CM

Horizontal de 63x33cm
Profundidad 10cm.
Fabricada en acero inox. S.304
6 acabados de color

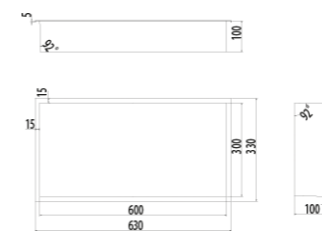
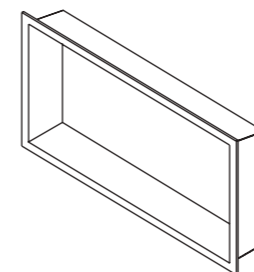

Ref: **HOR002/BL**
P.V.P: **126 €**
IVA NO INCLUIDO



Ref: **HOR002/NG**
P.V.P: **121 €**
IVA NO INCLUIDO



Ref: **HOR002/NQ**
P.V.P: **104 €**
IVA NO INCLUIDO



Ref: **HOR002/BGM**
P.V.P: **139 €**
IVA NO INCLUIDO



Ref: **HOR002/OC**
P.V.P: **134 €**
IVA NO INCLUIDO



Ref: **HOR002/ORC**
P.V.P: **145 €**
IVA NO INCLUIDO

ARTIC

SERIE



HORNACINA 33X63 CM

Vertical de 33x63cm, con dos estantes.
Profundidad 10cm.
Fabricada en acero inox. S.304
6 acabados de color



Ref.: **HOR003/BL**
P.V.P.: **136 €**
IVA NO INCLUIDO



Ref.: **HOR003/NG**
P.V.P.: **131 €**
IVA NO INCLUIDO



Ref.: **HOR003/NQ**
P.V.P.: **115 €**
IVA NO INCLUIDO



Ref.: **HOR003/BGM**
P.V.P.: **150 €**
IVA NO INCLUIDO



Ref.: **HOR003/OC**
P.V.P.: **145 €**
IVA NO INCLUIDO



Ref.: **HOR003/ORC**
P.V.P.: **155 €**
IVA NO INCLUIDO

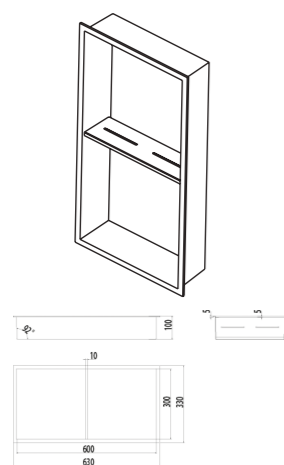

INDIC

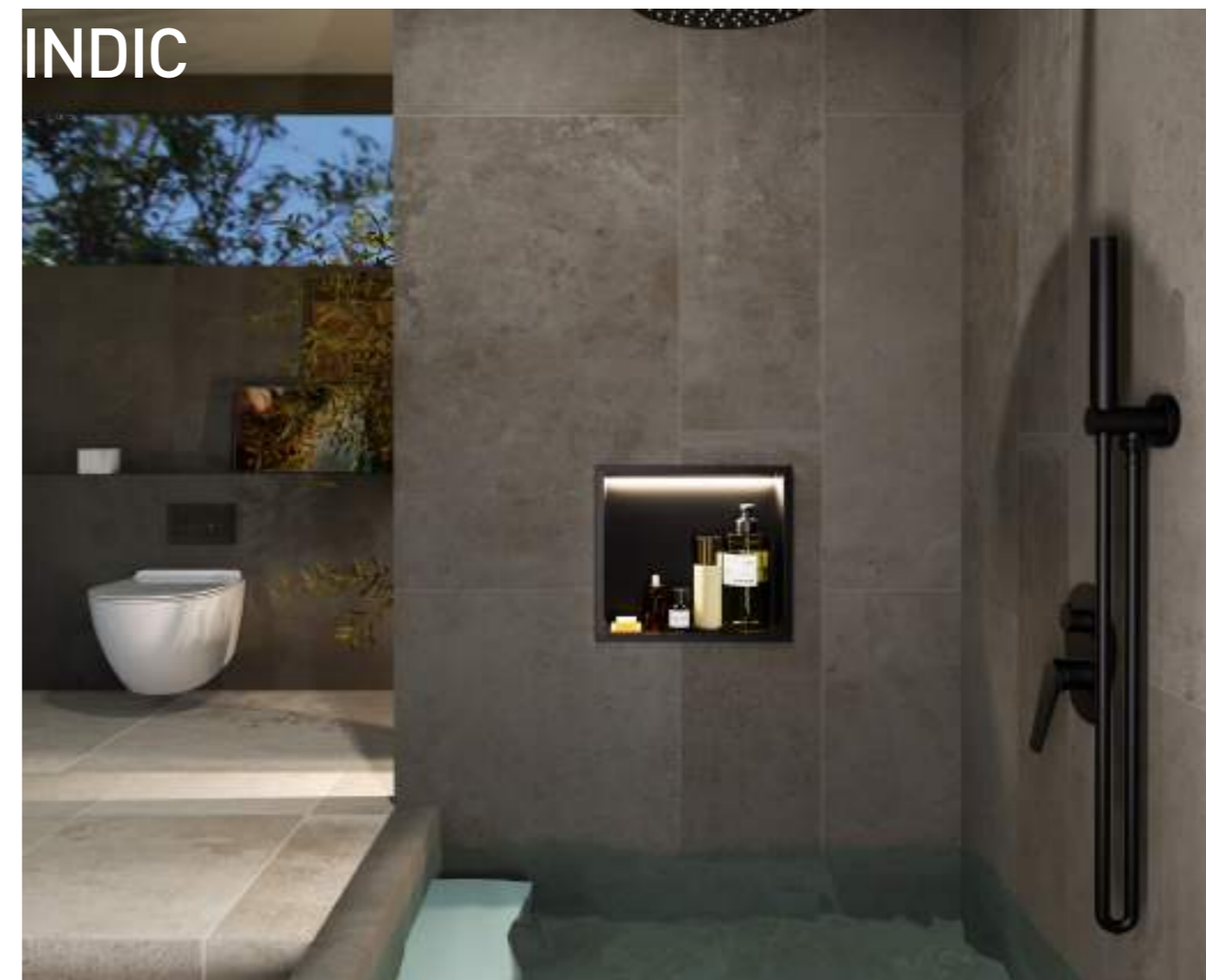

HORNACINA 33X33 CM

Cuadrada de 33x33cm con luz led.
Profundidad 10cm.
Fabricada en acero inox. S.304
6 acabados de color



Ref.: **HOR004/BL**
P.V.P.: **141 €**
IVA NO INCLUIDO



Ref.: **HOR004/NG**
P.V.P.: **137 €**
IVA NO INCLUIDO



Ref.: **HOR004/NQ**
P.V.P.: **127 €**
IVA NO INCLUIDO

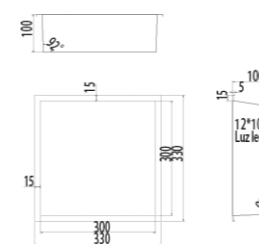
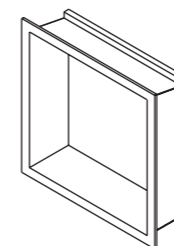

Ref.: **HOR004/BGM**
P.V.P.: **148 €**
IVA NO INCLUIDO



Ref.: **HOR004/OC**
P.V.P.: **144 €**
IVA NO INCLUIDO



Ref.: **HOR004/ORC**
P.V.P.: **148 €**
IVA NO INCLUIDO

(* Todos los acabados tienen la misma gama cromática de Imex Products.

(* Todos los acabados tienen la misma gama cromática de Imex Products.

OCEANIC

SERIE

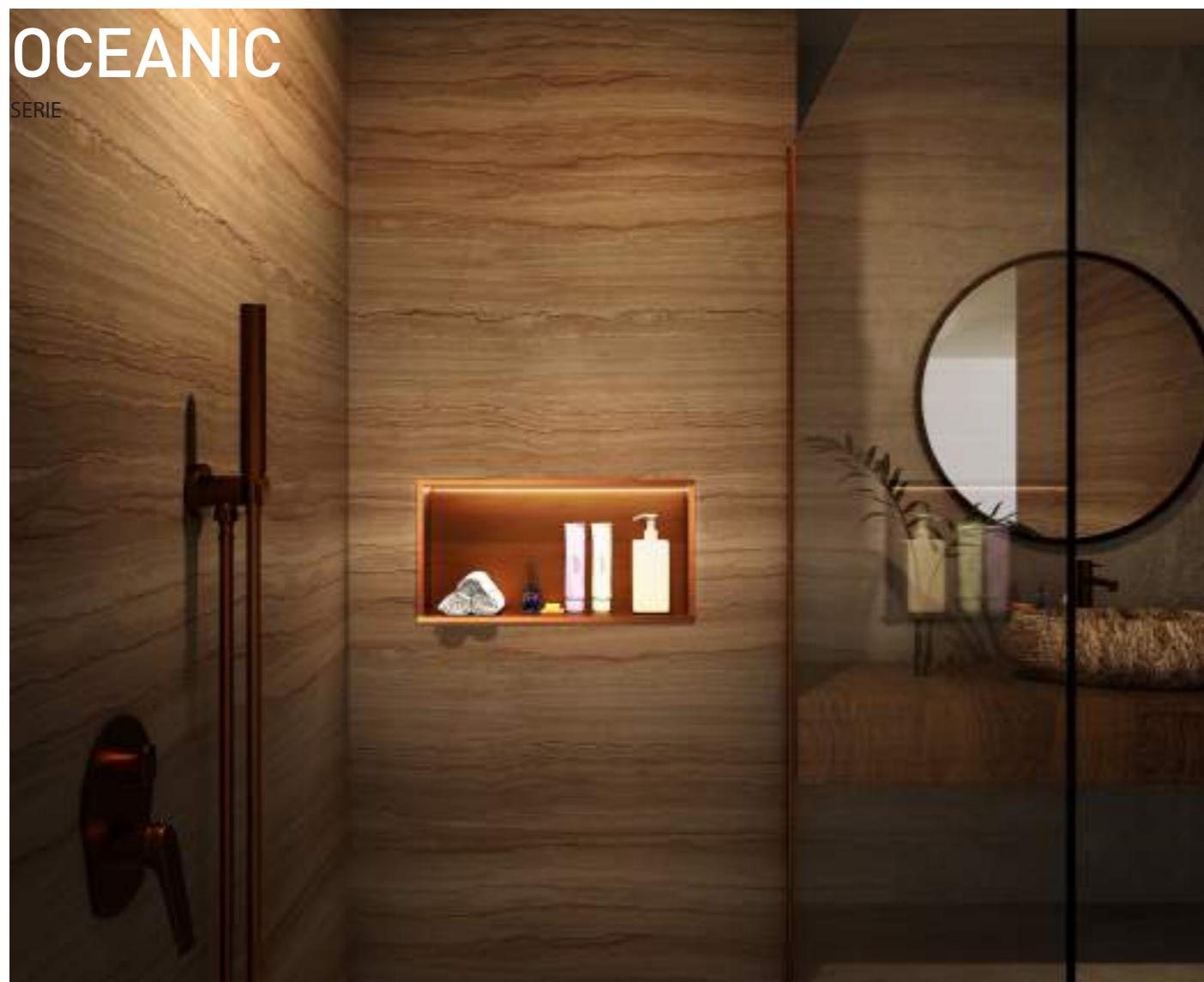

HORNACINA 63X33 CM

Horizontal de 63x33cm, con luz led.
Profundidad 10cm.
Fabricada en acero inox. S.304
6 acabados de color



Ref.: **HOR005/BL**
P.V.P.: **198 €**
IVA NO INCLUIDO



Ref.: **HOR005/NG**
P.V.P.: **194 €**
IVA NO INCLUIDO



Ref.: **HOR005/NQ**
P.V.P.: **172 €**
IVA NO INCLUIDO



Ref.: **HOR005/BGM**
P.V.P.: **205 €**
IVA NO INCLUIDO



Ref.: **HOR005/OC**
P.V.P.: **201 €**
IVA NO INCLUIDO



Ref.: **HOR005/ORC**
P.V.P.: **213 €**
IVA NO INCLUIDO

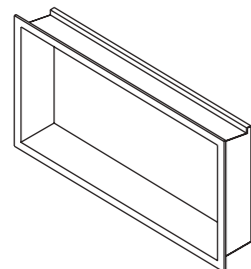

(*) Todos los acabados tienen la misma gama cromática de Imex Products.

MARSHALL

SERIE



HORNACINA 33X63 CM

Vertical de 33x63cm, de dos estantes con luz led.
Profundidad 10cm.
Fabricada en acero inox. S.304
6 acabados de color



Ref.: **HOR006/BL**
P.V.P.: **222 €**
IVA NO INCLUIDO



Ref.: **HOR006/NG**
P.V.P.: **216 €**
IVA NO INCLUIDO



Ref.: **HOR006/NQ**
P.V.P.: **198 €**
IVA NO INCLUIDO

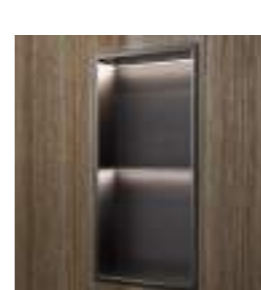

Ref.: **HOR006/BGM**
P.V.P.: **237 €**
IVA NO INCLUIDO

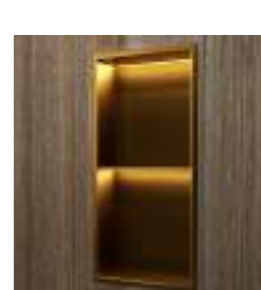

Ref.: **HOR006/OC**
P.V.P.: **231 €**
IVA NO INCLUIDO

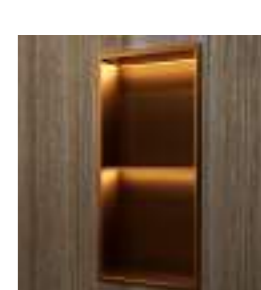

Ref.: **HOR006/ORC**
P.V.P.: **243 €**
IVA NO INCLUIDO

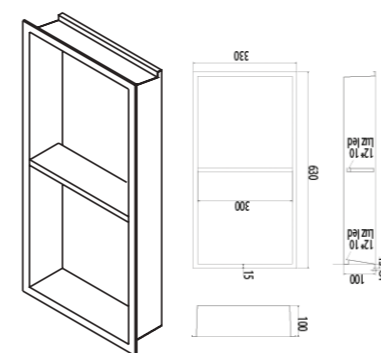

(*) Todos los acabados tienen la misma gama cromática de Imex Products.

EGEAN

SERIE

HORNACINA 17X60 CM

Vertical de 17x60cm, escobillero empotrado con porta-rollo.
Profundidad 10cm.
Fabricada en acero inox. S.304
6 acabados de color

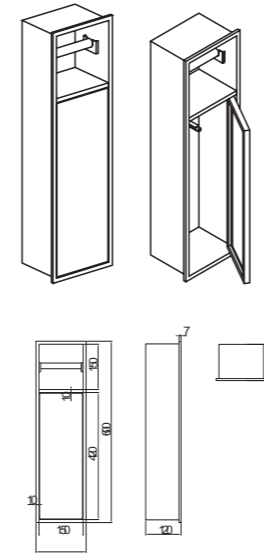

Ref: **HOR007/BL**
P.V.P: **214 €**
IVA NO INCLUIDO



Ref: **HOR007/NG**
P.V.P: **209 €**
IVA NO INCLUIDO



Ref: **HOR007/NQ**
P.V.P: **189 €**
IVA NO INCLUIDO



Ref: **HOR007/BGM**
P.V.P: **229 €**
IVA NO INCLUIDO



Ref: **HOR007/OC**
P.V.P: **223 €**
IVA NO INCLUIDO



Ref: **HOR007/ORC**
P.V.P: **234 €**
IVA NO INCLUIDO

(*) Todos los acabados tienen la misma gama cromática de Imex Products.



MEDIMEX

ABOUT ACCESSORIES



1010 (*) Todos los acabados tienen la misma gama cromática de Imex Products.

MEDIMEX

11

TIME

SERIE

PERCHA

Percha fabricada en acero inox. S.304.
6 acabados de color.
Fijación con tornillos.

| | | | | | |
|---|---------------------------|---|---|----------------------------|---|
|  | Ref.: CAT004-01 | P.V.P.: 17 € <small>IVA NO INCLUIDO</small> |  | Ref.: CAT004-01/BGM | P.V.P.: 19 € <small>IVA NO INCLUIDO</small> |
|  | Ref.: CAT004-01/NG | P.V.P.: 18 € <small>IVA NO INCLUIDO</small> |  | Ref.: CAT004-01/OC | P.V.P.: 19 € <small>IVA NO INCLUIDO</small> |
|  | Ref.: CAT004-01/NQ | P.V.P.: 16 € <small>IVA NO INCLUIDO</small> |  | Ref.: CAT004-01/ORC | P.V.P.: 19 € <small>IVA NO INCLUIDO</small> |



Installation Instruction of Serie



TIME

SERIE

TOALLERO 40

Toallero de 40cms fabricada en acero inox. S.304.
6 acabados de color.
Fijación con tornillos.

| | | | | | |
|---|---------------------------|---|---|----------------------------|---|
|  | Ref.: CAT004-03 | P.V.P.: 44 € <small>IVA NO INCLUIDO</small> |  | Ref.: CAT004-03/BGM | P.V.P.: 52 € <small>IVA NO INCLUIDO</small> |
|  | Ref.: CAT004-03/NG | P.V.P.: 46 € <small>IVA NO INCLUIDO</small> |  | Ref.: CAT004-03/OC | P.V.P.: 51 € <small>IVA NO INCLUIDO</small> |
|  | Ref.: CAT004-03/NQ | P.V.P.: 42 € <small>IVA NO INCLUIDO</small> |  | Ref.: CAT004-03/ORC | P.V.P.: 51 € <small>IVA NO INCLUIDO</small> |



PORTA-ROLLO

Porta-rollo fabricado en acero inox. S.304.
6 acabados de color.
Fijación con tornillos.

| | | | | | |
|---|---------------------------|---|---|----------------------------|---|
|  | Ref.: CAT004-08 | P.V.P.: 25 € <small>IVA NO INCLUIDO</small> |  | Ref.: CAT004-08/BGM | P.V.P.: 29 € <small>IVA NO INCLUIDO</small> |
|  | Ref.: CAT004-08/NG | P.V.P.: 26 € <small>IVA NO INCLUIDO</small> |  | Ref.: CAT004-08/OC | P.V.P.: 28 € <small>IVA NO INCLUIDO</small> |
|  | Ref.: CAT004-08/NQ | P.V.P.: 24 € <small>IVA NO INCLUIDO</small> |  | Ref.: CAT004-08/ORC | P.V.P.: 28 € <small>IVA NO INCLUIDO</small> |



TOALLERO 50

Toallero de 50cms fabricada en acero inox. S.304.
6 acabados de color.
Fijación con tornillos.

| | | | | | |
|---|---------------------------|---|---|----------------------------|---|
|  | Ref.: CAT004-04 | P.V.P.: 44 € <small>IVA NO INCLUIDO</small> |  | Ref.: CAT004-04/BGM | P.V.P.: 52 € <small>IVA NO INCLUIDO</small> |
|  | Ref.: CAT004-04/NG | P.V.P.: 46 € <small>IVA NO INCLUIDO</small> |  | Ref.: CAT004-04/OC | P.V.P.: 51 € <small>IVA NO INCLUIDO</small> |
|  | Ref.: CAT004-04/NQ | P.V.P.: 42 € <small>IVA NO INCLUIDO</small> |  | Ref.: CAT004-04/ORC | P.V.P.: 51 € <small>IVA NO INCLUIDO</small> |



ESCOBILLERO

Escobillero fabricado en acero inox. S.304.
6 acabados de color.
Fijación con tornillos.

| | | | | | |
|---|---------------------------|---|---|----------------------------|---|
|  | Ref.: CAT004-06 | P.V.P.: 37 € <small>IVA NO INCLUIDO</small> |  | Ref.: CAT004-06/BGM | P.V.P.: 42 € <small>IVA NO INCLUIDO</small> |
|  | Ref.: CAT004-06/NG | P.V.P.: 39 € <small>IVA NO INCLUIDO</small> |  | Ref.: CAT004-06/OC | P.V.P.: 41 € <small>IVA NO INCLUIDO</small> |
|  | Ref.: CAT004-06/NQ | P.V.P.: 36 € <small>IVA NO INCLUIDO</small> |  | Ref.: CAT004-06/ORC | P.V.P.: 41 € <small>IVA NO INCLUIDO</small> |



TOALLERO MULTIPLE

Toallero múltiple fabricada en acero inox. S.304.
6 acabados de color.
Fijación con tornillos.

| | | | | | |
|---|---------------------------|--|---|----------------------------|--|
|  | Ref.: CAT004-05 | P.V.P.: 104 € <small>IVA NO INCLUIDO</small> |  | Ref.: CAT004-05/BGM | P.V.P.: 132 € <small>IVA NO INCLUIDO</small> |
|  | Ref.: CAT004-05/NG | P.V.P.: 109 € <small>IVA NO INCLUIDO</small> |  | Ref.: CAT004-05/OC | P.V.P.: 128 € <small>IVA NO INCLUIDO</small> |
|  | Ref.: CAT004-05/NQ | P.V.P.: 96 € <small>IVA NO INCLUIDO</small> |  | Ref.: CAT004-05/ORC | P.V.P.: 128 € <small>IVA NO INCLUIDO</small> |



TECHNIC

SERIE

PERCHA

Percha fabricada en acero inox. S.304.
5 acabados de color.
Doble sistema de fijación incluido (atornillado y pegado).

Ref.: **CAT002-01** P.V.P.: **14 €**
IVA NO INCLUIDO

Ref.: **CAT002-01/NG** P.V.P.: **14 €**
IVA NO INCLUIDO



Ref.: **CAT002-01/BGM** P.V.P.: **18 €**
IVA NO INCLUIDO

Ref.: **CAT002-01/OC** P.V.P.: **16 €**
IVA NO INCLUIDO

Ref.: **CAT002-01/ORC** P.V.P.: **18 €**
IVA NO INCLUIDO



Installation Instruction of Serie

PERCHA TRIPLE

Percha triple fabricada en acero inox. S.304.
5 acabados de color.
Doble sistema de fijación incluido (atornillado y pegado).

Ref.: **CAT002-02** P.V.P.: **33 €**
IVA NO INCLUIDO

Ref.: **CAT002-02/NG** P.V.P.: **30 €**
IVA NO INCLUIDO



Ref.: **CAT002-02/BGM** P.V.P.: **40 €**
IVA NO INCLUIDO

Ref.: **CAT002-02/OC** P.V.P.: **37 €**
IVA NO INCLUIDO

Ref.: **CAT002-02/ORC** P.V.P.: **40 €**
IVA NO INCLUIDO



PORTA-ROLLO

Porta-rollo fabricado en acero inox. S.304.
5 acabados de color.
Doble sistema de fijación incluido (atornillado y pegado).

Ref.: **CAT002-08** P.V.P.: **20 €**
IVA NO INCLUIDO

Ref.: **CAT002-08/NG** P.V.P.: **20 €**
IVA NO INCLUIDO



Ref.: **CAT002-08/BGM** P.V.P.: **26 €**
IVA NO INCLUIDO

Ref.: **CAT002-08/OC** P.V.P.: **23 €**
IVA NO INCLUIDO

Ref.: **CAT002-08/ORC** P.V.P.: **26 €**
IVA NO INCLUIDO



TECHNIC

SERIE

TOALLERO 40

Toallero de 40cms fabricada en acero inox. S.304.
5 acabados de color.
Doble sistema de fijación incluido (atornillado y pegado).

Ref.: **CAT002-03** P.V.P.: **29 €**
IVA NO INCLUIDO

Ref.: **CAT002-03/NG** P.V.P.: **29 €**
IVA NO INCLUIDO



Ref.: **CAT002-03/BGM** P.V.P.: **38 €**
IVA NO INCLUIDO

Ref.: **CAT002-03/OC** P.V.P.: **33 €**
IVA NO INCLUIDO

Ref.: **CAT002-03/ORC** P.V.P.: **38 €**
IVA NO INCLUIDO



TOALLERO 50

Toallero de 50cms fabricada en acero inox. S.304.
5 acabados de color.
Doble sistema de fijación incluido (atornillado y pegado).

Ref.: **CAT002-04** P.V.P.: **29 €**
IVA NO INCLUIDO

Ref.: **CAT002-04/NG** P.V.P.: **29 €**
IVA NO INCLUIDO



Ref.: **CAT002-04/BGM** P.V.P.: **38 €**
IVA NO INCLUIDO

Ref.: **CAT002-04/OC** P.V.P.: **33 €**
IVA NO INCLUIDO

Ref.: **CAT002-04/ORC** P.V.P.: **38 €**
IVA NO INCLUIDO



TOALLERO MULTIPLE

Toallero múltiple fabricada en acero inox. S.304.
6 acabados de color.
Doble sistema de fijación incluido (atornillado y pegado).

Ref.: **CAT002-05** P.V.P.: **76 €**
IVA NO INCLUIDO

Ref.: **CAT002-05/NG** P.V.P.: **74 €**
IVA NO INCLUIDO



Ref.: **CAT002-05/BGM** P.V.P.: **98 €**
IVA NO INCLUIDO

Ref.: **CAT002-05/OC** P.V.P.: **86 €**
IVA NO INCLUIDO

Ref.: **CAT002-05/ORC** P.V.P.: **98 €**
IVA NO INCLUIDO



ESCOBILLERO

Escobillero fabricado en acero inox. S.304.
5 acabados de color.
Doble sistema de fijación incluido (atornillado y pegado).

Ref.: **CAT002-06** P.V.P.: **35 €**
IVA NO INCLUIDO

Ref.: **CAT002-06/NG** P.V.P.: **35 €**
IVA NO INCLUIDO



Ref.: **CAT002-06/BGM** P.V.P.: **46 €**
IVA NO INCLUIDO

Ref.: **CAT002-06/OC** P.V.P.: **40 €**
IVA NO INCLUIDO

Ref.: **CAT002-06/ORC** P.V.P.: **46 €**
IVA NO INCLUIDO



MEDIMEX

ABOUT ACCESSORIES



PRACTIC

SERIE

PERCHA

Percha fabricada en acero inox. S.316 y 5 acabados de color en acero inox. S.304. Doble sistema de fijación incluido (atornillado y pegado).

- Ref: **CAP003-01** P.V.P.: **14 €**
IVA NO INCLUIDO
- Ref: **CAP003-01/NG** P.V.P.: **14 €**
IVA NO INCLUIDO
- Ref: **CAP003-01/AC** P.V.P.: **16 €**
IVA NO INCLUIDO



- Ref: **CAP003-01/BGM** P.V.P.: **16 €**
IVA NO INCLUIDO
- Ref: **CAP003-01/OC** P.V.P.: **15 €**
IVA NO INCLUIDO
- Ref: **CAP003-01/ORC** P.V.P.: **16 €**
IVA NO INCLUIDO



Installation Instruction of Serie



PERCHA TRIPLE

Percha triple fabricada en acero inox. S.316 y 5 acabados de color en acero inox. S.304. Doble sistema de fijación incluido (atornillado y pegado).

- Ref: **CAP003-02** P.V.P.: **31 €**
IVA NO INCLUIDO
- Ref: **CAP003-02/NG** P.V.P.: **31 €**
IVA NO INCLUIDO
- Ref: **CAP003-02/AC** P.V.P.: **36 €**
IVA NO INCLUIDO



- Ref: **CAP003-02/BGM** P.V.P.: **39 €**
IVA NO INCLUIDO
- Ref: **CAP003-02/OC** P.V.P.: **36 €**
IVA NO INCLUIDO
- Ref: **CAP003-02/ORC** P.V.P.: **39 €**
IVA NO INCLUIDO



PORTA-ROLLO

Porta-rollo fabricado en acero inox. S.316 y 5 acabados de color en acero inox. S.304. Doble sistema de fijación incluido (atornillado y pegado).

- Ref: **CAP003-08** P.V.P.: **20 €**
IVA NO INCLUIDO
- Ref: **CAP003-08/NG** P.V.P.: **20 €**
IVA NO INCLUIDO
- Ref: **CAP003-08/AC** P.V.P.: **22 €**
IVA NO INCLUIDO



- Ref: **CAP003-08/BGM** P.V.P.: **24 €**
IVA NO INCLUIDO
- Ref: **CAP003-08/OC** P.V.P.: **22 €**
IVA NO INCLUIDO
- Ref: **CAP003-08/ORC** P.V.P.: **24 €**
IVA NO INCLUIDO



ESCOBILLERO CON PORTA-ROLLO

Escobillero con porta-rollo fabricado en acero inox. S.316 y 5 acabados de color en acero inox. S.304. Doble sistema de fijación incluido (atornillado y pegado).

- Ref: **CAP003-07** P.V.P.: **79 €**
IVA NO INCLUIDO
- Ref: **CAP003-07/NG** P.V.P.: **79 €**
IVA NO INCLUIDO
- Ref: **CAP003-07/AC** P.V.P.: **100 €**
IVA NO INCLUIDO



- Ref: **CAP003-07/BGM** P.V.P.: **98 €**
IVA NO INCLUIDO
- Ref: **CAP003-07/OC** P.V.P.: **89 €**
IVA NO INCLUIDO
- Ref: **CAP003-07/ORC** P.V.P.: **98 €**
IVA NO INCLUIDO



PRACTIC

SERIE

TOALLERO 40

Toallero de 40cms fabricada en acero inox. S.316 y 5 acabados de color en acero inox. S.304. Doble sistema de fijación incluido (atornillado y pegado).

- Ref: **CAP003-03** P.V.P.: **28 €**
IVA NO INCLUIDO
- Ref: **CAP003-03/NG** P.V.P.: **28 €**
IVA NO INCLUIDO
- Ref: **CAP003-03/AC** P.V.P.: **33 €**
IVA NO INCLUIDO



- Ref: **CAP003-03/BGM** P.V.P.: **36 €**
IVA NO INCLUIDO
- Ref: **CAP003-03/OC** P.V.P.: **31 €**
IVA NO INCLUIDO
- Ref: **CAP003-03/ORC** P.V.P.: **36 €**
IVA NO INCLUIDO



TOALLERO 50

Toallero de 50cms fabricada en acero inox. S.316 y 5 acabados de color en acero inox. S.304. Doble sistema de fijación incluido (atornillado y pegado).

- Ref: **CAP003-04** P.V.P.: **28 €**
IVA NO INCLUIDO
- Ref: **CAP003-04/NG** P.V.P.: **28 €**
IVA NO INCLUIDO
- Ref: **CAP003-04/AC** P.V.P.: **33 €**
IVA NO INCLUIDO



- Ref: **CAP003-04/BGM** P.V.P.: **36 €**
IVA NO INCLUIDO
- Ref: **CAP003-04/OC** P.V.P.: **31 €**
IVA NO INCLUIDO
- Ref: **CAP003-04/ORC** P.V.P.: **36 €**
IVA NO INCLUIDO



TOALLERO MULTIPLE

Toallero múltiple fabricada en acero inox. S.316 y 5 acabados de color en acero inox. S.304. Doble sistema de fijación incluido (atornillado y pegado).

- Ref: **CAP003-05** P.V.P.: **64 €**
IVA NO INCLUIDO
- Ref: **CAP003-05/NG** P.V.P.: **64 €**
IVA NO INCLUIDO
- Ref: **CAP003-05/AC** P.V.P.: **74 €**
IVA NO INCLUIDO



- Ref: **CAP003-05/BGM** P.V.P.: **84 €**
IVA NO INCLUIDO
- Ref: **CAP003-05/OC** P.V.P.: **75 €**
IVA NO INCLUIDO
- Ref: **CAP003-05/ORC** P.V.P.: **84 €**
IVA NO INCLUIDO



ESCOBILLERO

Escobillero fabricado en acero inox. S.316 y 5 acabados de color en acero inox. S.304. Doble sistema de fijación incluido (atornillado y pegado).

- Ref: **CAP003-06** P.V.P.: **34 €**
IVA NO INCLUIDO
- Ref: **CAP003-06/NG** P.V.P.: **34 €**
IVA NO INCLUIDO
- Ref: **CAP003-06/AC** P.V.P.: **40 €**
IVA NO INCLUIDO



- Ref: **CAP003-06/BGM** P.V.P.: **43 €**
IVA NO INCLUIDO
- Ref: **CAP003-06/OC** P.V.P.: **39 €**
IVA NO INCLUIDO
- Ref: **CAP003-06/ORC** P.V.P.: **43 €**
IVA NO INCLUIDO





ESSENTIAL



SERIE

PERCHA

Percha fabricada en acero inox. S.304.
6 acabados de color.
Doble sistema de fijación incluido (atornillado y pegado).

-  Ref.: CAE001-01 P.V.P.: 10 €
IVA NO INCLUIDO
-  Ref.: CAE001-01/NG P.V.P.: 10 €
IVA NO INCLUIDO
-  Ref.: CAE001-01/NQ P.V.P.: 9 €
IVA NO INCLUIDO



-  Ref.: CAE001-01/BGM P.V.P.: 13 €
IVA NO INCLUIDO
-  Ref.: CAE001-01/OC P.V.P.: 12 €
IVA NO INCLUIDO
-  Ref.: CAE001-01/ORC P.V.P.: 13 €
IVA NO INCLUIDO





Installation Instruction of Serie





PERCHA TRIPLE

Percha triple fabricada en acero inox. S.304.
6 acabados de color.
Doble sistema de fijación incluido (atornillado y pegado).

-  Ref.: CAE001-02 P.V.P.: 22 €
IVA NO INCLUIDO
-  Ref.: CAE001-02/NG P.V.P.: 20 €
IVA NO INCLUIDO
-  Ref.: CAE001-02/NQ P.V.P.: 18 €
IVA NO INCLUIDO





-  Ref.: CAE001-02/BGM P.V.P.: 26 €
IVA NO INCLUIDO
-  Ref.: CAE001-02/OC P.V.P.: 24 €
IVA NO INCLUIDO
-  Ref.: CAE001-02/ORC P.V.P.: 26 €
IVA NO INCLUIDO





PORTA-ROLLO

Porta-rollo fabricado en acero inox. S.304.
6 acabados de color.
Doble sistema de fijación incluido (atornillado y pegado).

-  Ref.: CAE001-08 P.V.P.: 14 €
IVA NO INCLUIDO
-  Ref.: CAE001-08/NG P.V.P.: 14 €
IVA NO INCLUIDO
-  Ref.: CAE001-08/NQ P.V.P.: 12 €
IVA NO INCLUIDO





-  Ref.: CAE001-08/BGM P.V.P.: 18 €
IVA NO INCLUIDO
-  Ref.: CAE001-08/OC P.V.P.: 16 €
IVA NO INCLUIDO
-  Ref.: CAE001-08/ORC P.V.P.: 18 €
IVA NO INCLUIDO





PORTA-ROLLO CON REPISA

Porta-rollo con repisa fabricado en acero inox. S.304.
6 acabados de color.
Doble sistema de fijación incluido (atornillado y pegado).

-  Ref.: CAE001-09 P.V.P.: 21 €
IVA NO INCLUIDO
-  Ref.: CAE001-09/NG P.V.P.: 20 €
IVA NO INCLUIDO
-  Ref.: CAE001-09/NQ P.V.P.: 19 €
IVA NO INCLUIDO



-  Ref.: CAE001-09/BGM P.V.P.: 27 €
IVA NO INCLUIDO
-  Ref.: CAE001-09/OC P.V.P.: 25 €
IVA NO INCLUIDO
-  Ref.: CAE001-09/ORC P.V.P.: 27 €
IVA NO INCLUIDO





ESSENTIAL



SERIE

TOALLERO 40

Toallero de 40cms fabricada en acero inox. S.304.
6 acabados de color.
Doble sistema de fijación incluido (atornillado y pegado).

-  Ref.: CAE001-03 P.V.P.: 18 €
IVA NO INCLUIDO
-  Ref.: CAE001-03/NG P.V.P.: 17 €
IVA NO INCLUIDO
-  Ref.: CAE001-03/NQ P.V.P.: 15 €
IVA NO INCLUIDO





-  Ref.: CAE001-03/BGM P.V.P.: 23 €
IVA NO INCLUIDO
-  Ref.: CAE001-03/OC P.V.P.: 21 €
IVA NO INCLUIDO
-  Ref.: CAE001-03/ORC P.V.P.: 23 €
IVA NO INCLUIDO

MEDIMEX





TOALLERO 50

Toallero de 50cms fabricada en acero inox. S.304.
6 acabados de color.
Doble sistema de fijación incluido (atornillado y pegado).

-  Ref.: CAE001-04 P.V.P.: 18 €
IVA NO INCLUIDO
-  Ref.: CAE001-04/NG P.V.P.: 17 €
IVA NO INCLUIDO
-  Ref.: CAE001-04/NQ P.V.P.: 15 €
IVA NO INCLUIDO





-  Ref.: CAE001-04/BGM P.V.P.: 23 €
IVA NO INCLUIDO
-  Ref.: CAE001-04/OC P.V.P.: 21 €
IVA NO INCLUIDO
-  Ref.: CAE001-04/ORC P.V.P.: 23 €
IVA NO INCLUIDO





TOALLERO MULTIPLE

Toallero múltiple fabricada en acero inox. S.304.
6 acabados de color.
Doble sistema de fijación incluido (atornillado y pegado).

-  Ref.: CAE001-05 P.V.P.: 47 €
IVA NO INCLUIDO
-  Ref.: CAE001-05/NG P.V.P.: 45 €
IVA NO INCLUIDO
-  Ref.: CAE001-05/NQ P.V.P.: 40 €
IVA NO INCLUIDO





-  Ref.: CAE001-05/BGM P.V.P.: 62 €
IVA NO INCLUIDO
-  Ref.: CAE001-05/OC P.V.P.: 56 €
IVA NO INCLUIDO
-  Ref.: CAE001-05/ORC P.V.P.: 62 €
IVA NO INCLUIDO





ESCOBILLERO

Escobillero fabricado en acero inox. S.304.
6 acabados de color.
Doble sistema de fijación incluido (atornillado y pegado).

-  Ref.: CAE001-06 P.V.P.: 34 €
IVA NO INCLUIDO
-  Ref.: CAE001-06/NG P.V.P.: 34 €
IVA NO INCLUIDO
-  Ref.: CAE001-06/NQ P.V.P.: 31 €
IVA NO INCLUIDO



-  Ref.: CAE001-06/BGM P.V.P.: 43 €
IVA NO INCLUIDO
-  Ref.: CAE001-06/OC P.V.P.: 39 €
IVA NO INCLUIDO
-  Ref.: CAE001-06/ORC P.V.P.: 43 €
IVA NO INCLUIDO



ACCESORIOS

SERIE

ASA DE DUCHA

Asa de ducha fabricada en acero inox. S.316 y 6 acabados de color en acero inox. S.304.
Fijación con tornillos.

- | | | | |
|--|---|---|---|
|  Ref.: AAS004 | P.V.P.: 21 € <small>IVA NO INCLUIDO</small> |  Ref.: AAS004/BGM | P.V.P.: 39 € <small>IVA NO INCLUIDO</small> |
|  Ref.: AAS004/NG | P.V.P.: 31 € <small>IVA NO INCLUIDO</small> |  Ref.: AAS004/OC | P.V.P.: 37 € <small>IVA NO INCLUIDO</small> |
|  Ref.: AAS004/NQ | P.V.P.: 31 € <small>IVA NO INCLUIDO</small> |  Ref.: AAS004/ORC | P.V.P.: 37 € <small>IVA NO INCLUIDO</small> |
|  Ref.: AAS004/AC | P.V.P.: 39 € <small>IVA NO INCLUIDO</small> | | |



MAYURA

SERIE

JABONERA FRONTAL

Jabonera frontal fabricada en acero inox. S.316 y 6 acabados de color en acero inox. S.304.
Fijación con tornillos.

- | | | | |
|--|---|---|---|
|  Ref.: ADY007 | P.V.P.: 61 € <small>IVA NO INCLUIDO</small> |  Ref.: ADY007/BGM | P.V.P.: 61 € <small>IVA NO INCLUIDO</small> |
|  Ref.: ADY007/NG | P.V.P.: 61 € <small>IVA NO INCLUIDO</small> |  Ref.: ADY007/OC | P.V.P.: 61 € <small>IVA NO INCLUIDO</small> |
|  Ref.: ADY007/NQ | P.V.P.: 61 € <small>IVA NO INCLUIDO</small> |  Ref.: ADY007/ORC | P.V.P.: 61 € <small>IVA NO INCLUIDO</small> |
|  Ref.: ADY007/AC | P.V.P.: 61 € <small>IVA NO INCLUIDO</small> | | |



TOALLERO PARA MUEBLE

Toallero para mueble fabricado en acero inox. S.316 y 6 acabados de color en acero inox. S.304.

- | | | | |
|--|---|---|---|
|  Ref.: SPA001 | P.V.P.: 22 € <small>IVA NO INCLUIDO</small> |  Ref.: SPA001/BGM | P.V.P.: 31 € <small>IVA NO INCLUIDO</small> |
|  Ref.: SPA001/NG | P.V.P.: 29 € <small>IVA NO INCLUIDO</small> |  Ref.: SPA001/OC | P.V.P.: 31 € <small>IVA NO INCLUIDO</small> |
|  Ref.: SPA001/NQ | P.V.P.: 29 € <small>IVA NO INCLUIDO</small> |  Ref.: SPA001/ORC | P.V.P.: 31 € <small>IVA NO INCLUIDO</small> |
|  Ref.: SPA001/AC | P.V.P.: 31 € <small>IVA NO INCLUIDO</small> | | |



JABONERA DE COLGAR

Jabonera para colgar en grifería fabricada en acero inox. S.316 y 6 acabados de color en acero inox. S.304.

- | | | | |
|--|---|---|---|
|  Ref.: ADG003 | P.V.P.: 39 € <small>IVA NO INCLUIDO</small> |  Ref.: ADG003/BGM | P.V.P.: 45 € <small>IVA NO INCLUIDO</small> |
|  Ref.: ADG003/NG | P.V.P.: 41 € <small>IVA NO INCLUIDO</small> |  Ref.: ADG003/OC | P.V.P.: 45 € <small>IVA NO INCLUIDO</small> |
|  Ref.: ADG003/NQ | P.V.P.: 41 € <small>IVA NO INCLUIDO</small> |  Ref.: ADG003/ORC | P.V.P.: 45 € <small>IVA NO INCLUIDO</small> |
|  Ref.: ADG003/AC | P.V.P.: 45 € <small>IVA NO INCLUIDO</small> | | |

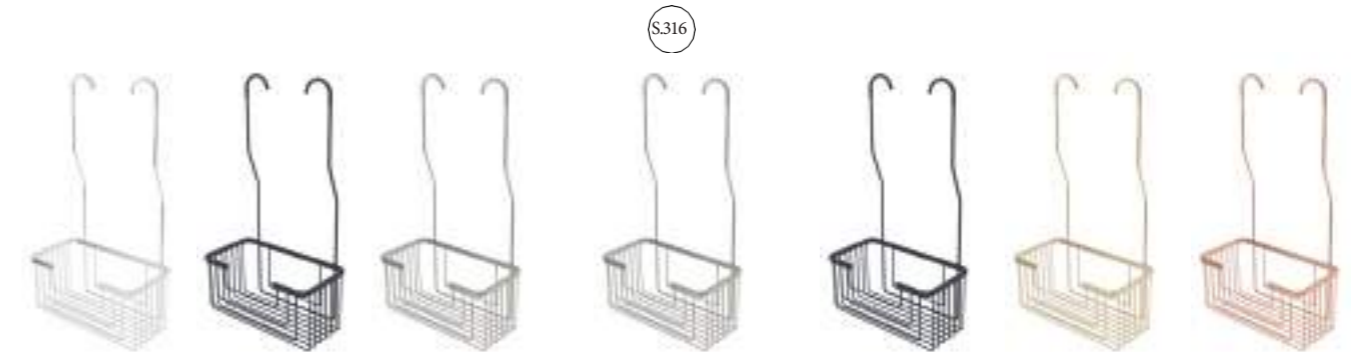

EXPOSITORES



▲ Ref: **MEXP001**

*Expositor de sobre mesa para accesorios de baño.
Medidas 320x320x120 mm*

◀ Ref: **MEXP002**

*Expositor de pared para accesorios de baño.
Medidas 2200x700 mm*

X
MEDIMEX

ABOUT ACCESSORIES



MEDIMEX

www.mediterraneadelbano.es



Pol. Ind. Torrent
C/dels Ollers, 12
46900 - Torrent (Valencia)



(+34) 961 588 195
(+34) 680 825 645
accesorios@mediterraneadelbano.es